

### General Description

The AAT4608 SmartSwitch is a member of AnalogicTech's Application Specific Power MOSFET™ (ASPM™) product family. It is a current limited P-channel MOSFET power switch designed for high-side load switching applications. This switch operates with inputs ranging from 2.7V to 5.5V, making it ideal for both 3V and 5V systems. An integrated current-limiting circuit protects the input supply against large currents which may cause the supply to fall out of regulation. The AAT4608 is also protected from thermal overload which limits power dissipation and junction temperatures. It can be used to control loads that require up to 1A. Current limit threshold is programmed with a resistor from SET to ground. The quiescent supply current is typically a low 15µA max.

The AAT4608 is available in a Pb-free, 5-pin SOT23 package, and is specified over the -40°C to +85°C temperature range.

### Features

- 2.7V to 5.5V Input Voltage Range
- Programmable Over-Current Threshold
- Fast Transient Response:
  - <1µs Response to Short Circuit
- Low Quiescent Current
  - 15µA Typical
  - 1µA Max With Switch Off
- 160mΩ Typical  $R_{DS(ON)}$
- Under-Voltage Lockout
- Thermal Shutdown
- Temperature Range: -40°C to +85°C
- 4kV ESD Rating
- 5-Pin SOT23 Package

### Applications

- Hot Swap Supplies
- Notebook Computers
- Peripheral Ports
- Personal Communication Devices

### Typical Application

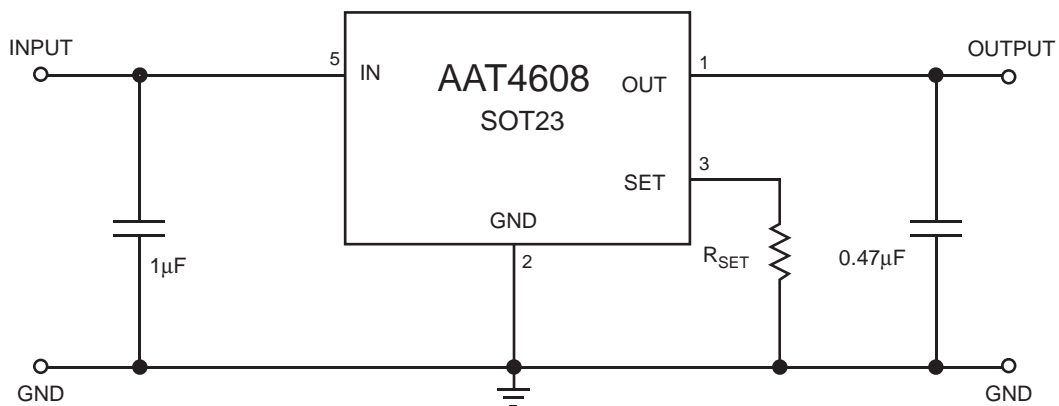

## Pin Descriptions

| Pin # | Symbol | Function                                                                                      |
|-------|--------|-----------------------------------------------------------------------------------------------|
| 1     | OUT    | P-channel MOSFET drain. Connect 0.47 $\mu$ F capacitor from OUT to GND.                       |
| 2     | GND    | Ground connection.                                                                            |
| 3     | SET    | Current limit set input. A resistor from SET to ground sets the current limit for the switch. |
| 4     | N/C    | No internal connection.                                                                       |
| 5     | IN     | P-channel MOSFET source. Connect 1 $\mu$ F capacitor from IN to GND.                          |

## Pin Configuration

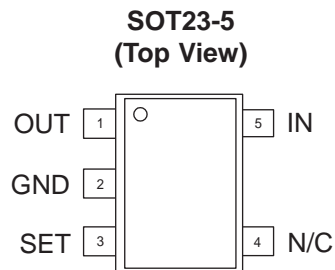

### Absolute Maximum Ratings<sup>1</sup>

$T_A = 25^\circ\text{C}$  unless otherwise noted.

| Symbol             | Description                              | Value                  | Units            |
|--------------------|------------------------------------------|------------------------|------------------|
| $V_{IN}$           | IN to GND                                | -0.3 to 6              | V                |
| $V_{SET}, V_{OUT}$ | SET, OUT to GND                          | -0.3 to $V_{IN} + 0.3$ | V                |
| $I_{MAX}$          | Maximum Continuous Switch Current        | 2                      | A                |
| $T_J$              | Operating Junction Temperature Range     | -40 to 150             | $^\circ\text{C}$ |
| $T_{LEAD}$         | Maximum Soldering Temperature (at Leads) | 300                    | $^\circ\text{C}$ |
| $V_{ESD}$          | ESD Rating <sup>2</sup> - HBM            | 4000                   | V                |

### Thermal Characteristics<sup>3</sup>

| Symbol        | Description        | Value | Units                     |
|---------------|--------------------|-------|---------------------------|
| $\theta_{JA}$ | Thermal Resistance | 150   | $^\circ\text{C}/\text{W}$ |
| $P_D$         | Power Dissipation  | 667   | mW                        |

### Electrical Characteristics

$V_{IN} = 5\text{V}$ ,  $T_A = -40^\circ\text{C}$  to  $+85^\circ\text{C}$ , unless otherwise noted. Typical values are at  $T_A = 25^\circ\text{C}$ .

| Symbol         | Description                 | Conditions                           | Min | Typ | Max | Units         |
|----------------|-----------------------------|--------------------------------------|-----|-----|-----|---------------|
| $V_{IN}$       | Operation Voltage           |                                      | 2.7 |     | 5.5 | V             |
| $I_Q$          | Quiescent Current           | $V_{IN} = 5\text{V}$ , $I_{OUT} = 0$ |     | 15  | 30  | $\mu\text{A}$ |
| $V_{UVLO}$     | Under-Voltage Lockout       | Rising Edge, 1% Hysteresis           | 2.0 | 2.3 | 2.7 | V             |
| $R_{DS(ON)}$   | On Resistance               | $V_{IN} = 5.0\text{V}$               |     | 160 | 180 | m $\Omega$    |
|                |                             | $V_{IN} = 4.5\text{V}$               |     | 165 |     |               |
|                |                             | $V_{IN} = 3.0\text{V}$               |     | 195 | 230 |               |
| $I_{LIM}$      | Current Limit               | $R_{SET} = 6.8\text{k}\Omega$        | 0.5 | 1   | 2.0 | A             |
| $I_{LIM(MIN)}$ | Minimum Current Limit       |                                      |     | 150 |     | mA            |
| $T_{RESP}$     | Current Limit Response Time | $V_{IN} = 5\text{V}$                 |     | 0.8 |     | $\mu\text{s}$ |

- Stresses above those listed in Absolute Maximum Ratings may cause permanent damage to the device. Functional operation at conditions other than the operating conditions specified is not implied. Only one Absolute Maximum Rating should be applied at any one time.
- Human body model is a 100pF capacitor discharged through a 1.5k $\Omega$  resistor into each pin.
- Mounted on a demo board.

### Typical Characteristics

Unless otherwise noted,  $V_{IN} = 5V$ ,  $T_A = 25^\circ C$ .

Quiescent Current vs. Temperature

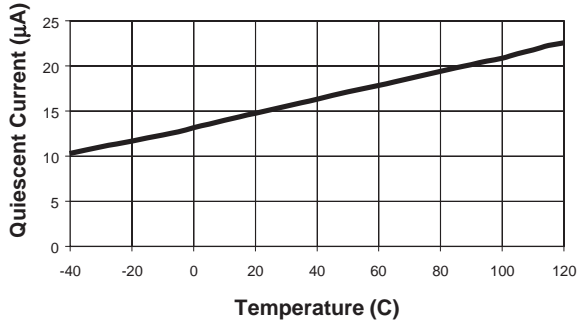

Quiescent Current

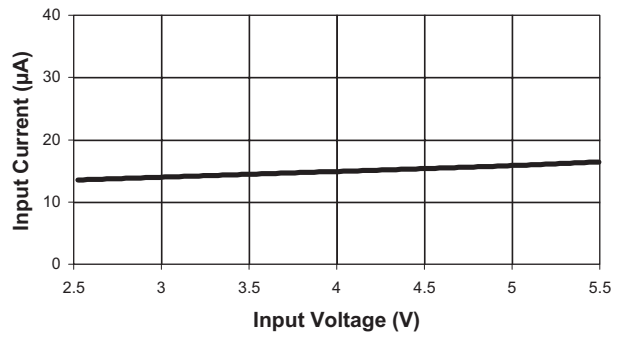

Output Current vs. Output Voltage  
( $R_{SET} = 16k\Omega$ )

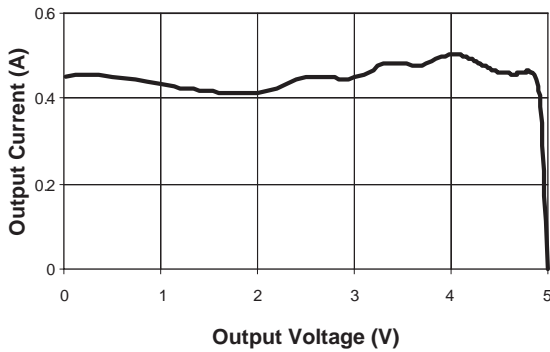

$R_{DS(ON)}$  vs. Temperature

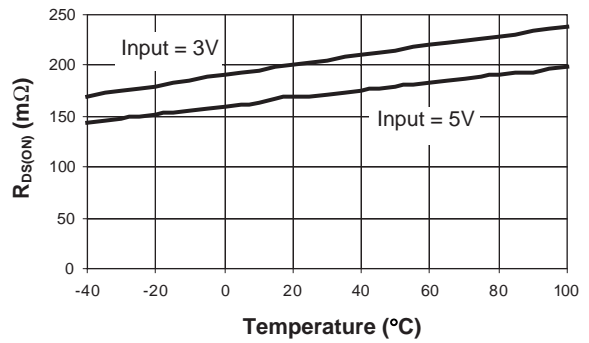

Short Circuit Through 0.3Ω

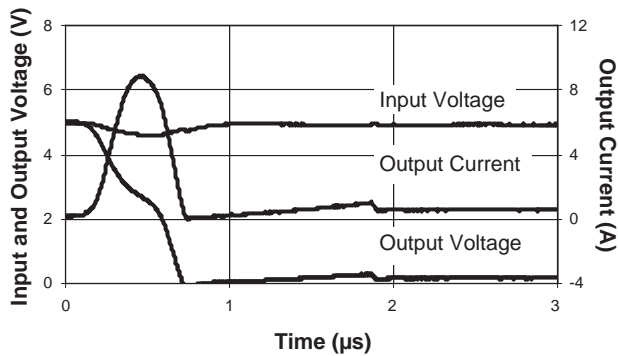

Short Circuit Through 0.6Ω

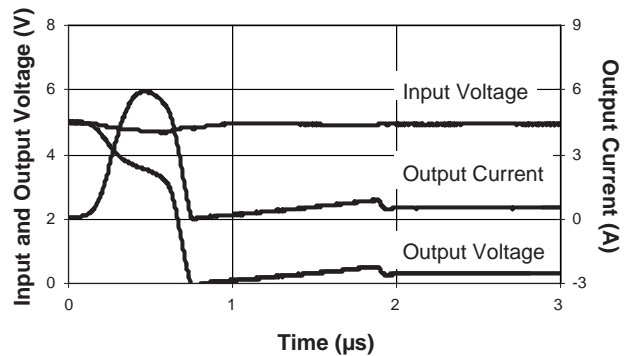

### Typical Characteristics

Unless otherwise noted,  $V_{IN} = 5V$ ,  $T_A = 25^\circ C$ .

**$R_{SET}$  vs.  $I_{LIM}$**

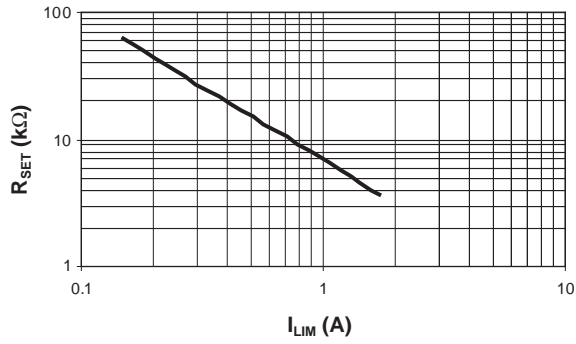

**$R_{SET}$  Coefficient vs.  $I_{LIM}$**

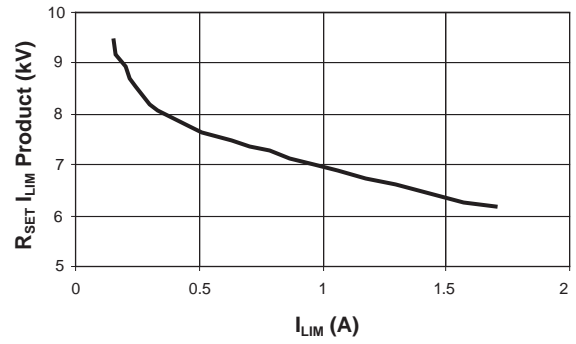

**Current Limit vs. Temperature**

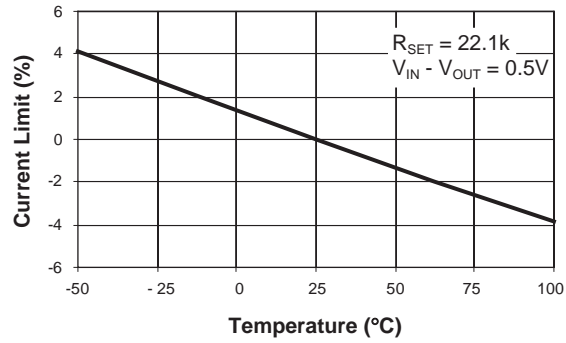

## Functional Block Diagram

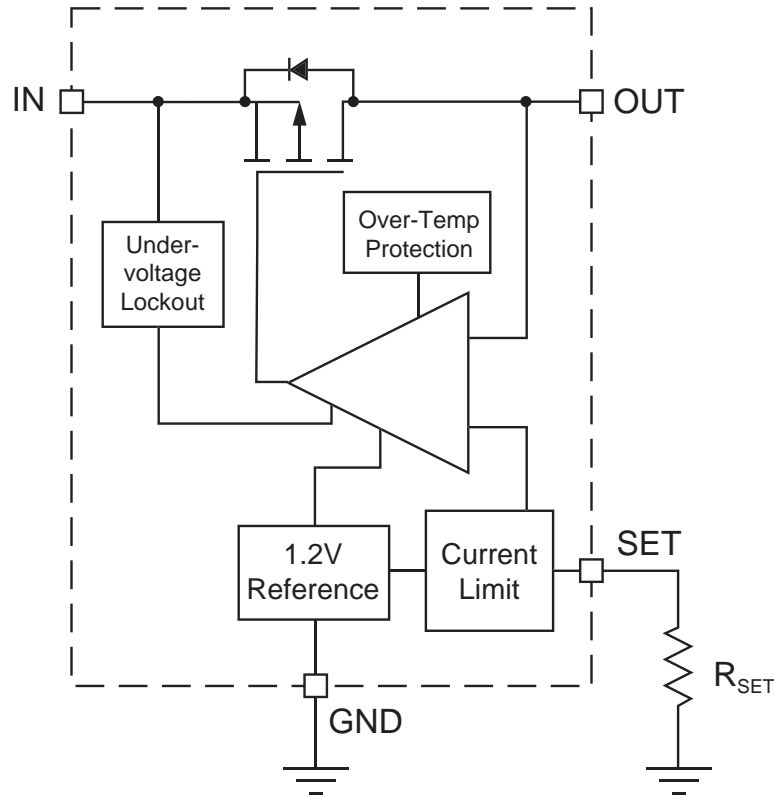

## Applications Information

### Setting Current Limit

In most applications, the variation in  $I_{LIM}$  must be taken into account when determining  $R_{SET}$ . The  $I_{LIM}$  variation is due to processing variations from part to part, as well as variations in the voltages at IN (Pin 5) and OUT (Pin 1), plus the operating temperature. See charts "Current Limit vs. Temperature," and "Output Current vs.  $V_{OUT}$ ." Together these three factors add up to a  $\pm 25\%$  tolerance (see  $I_{LIM}$  specification in Electrical Characteristics section). In the figure below, a cold device with a statistically higher current limit, and a hot device with a statistically lower current limit, both with  $R_{SET}$  equal to  $10.5k\Omega$ , are shown. While the chart, " $R_{SET}$  vs.  $I_{LIM}$ " indicates an  $I_{LIM}$  of  $0.7A$  with an  $R_{SET}$  of  $10.5k\Omega$ , this figure shows that the actual current limit will be at least  $0.525A$ , and no greater than  $0.880A$ .

Current Limit Using  $10.5k\Omega$

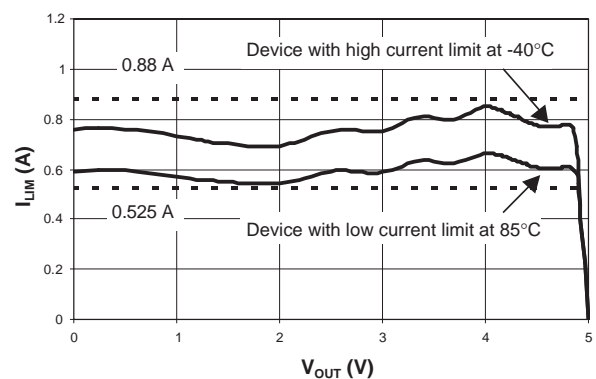

To determine  $R_{SET}$ , start with the maximum current drawn by the load and multiply it by 1.33. (Typical  $I_{LIM} = \text{minimum } I_{LIM} / 0.75$ .) This is the typical current limit value. Next, refer to " $R_{SET}$  vs.  $I_{LIM}$ " and find the  $R_{SET}$  that corresponds to the typ-

ical current limit value. Choose the largest resistor available that is less than or equal to it. For greater precision, the value of  $R_{SET}$  may also be calculated using the  $I_{LIM} R_{SET}$  product found in the chart "R<sub>SET</sub> coefficient vs. I<sub>LIM</sub>." The maximum current is derived by multiplying the typical current for the chosen  $R_{SET}$  in the chart by 1.25. A few standard resistor values are listed in Table 1.

| $R_{SET}$ (k $\Omega$ ) | Current Limit (Typ) (mA) | Device Will Not Current Limit Below (mA) | Device Always Current Limits Below (mA) |
|-------------------------|--------------------------|------------------------------------------|-----------------------------------------|
| 40.2                    | 200                      | 150                                      | 250                                     |
| 30.9                    | 250                      | 188                                      | 313                                     |
| 24.9                    | 300                      | 225                                      | 375                                     |
| 22.1                    | 350                      | 263                                      | 438                                     |
| 19.6                    | 400                      | 300                                      | 500                                     |
| 17.8                    | 450                      | 338                                      | 563                                     |
| 16.2                    | 500                      | 375                                      | 625                                     |
| 14.7                    | 550                      | 413                                      | 688                                     |
| 13.0                    | 600                      | 450                                      | 750                                     |
| 10.5                    | 700                      | 525                                      | 875                                     |
| 8.87                    | 800                      | 600                                      | 1000                                    |
| 7.50                    | 900                      | 675                                      | 1125                                    |
| 6.81                    | 1000                     | 750                                      | 1250                                    |
| 6.04                    | 1100                     | 825                                      | 1375                                    |
| 5.49                    | 1200                     | 900                                      | 1500                                    |
| 4.99                    | 1300                     | 975                                      | 1625                                    |
| 4.64                    | 1400                     | 1050                                     | 1750                                    |

**Table 1: Current Limit  $R_{SET}$  Values.**

Example: A USB port requires 0.5A. 0.5A multiplied by 1.33 is 0.665A. From the chart named "R<sub>SET</sub> vs. I<sub>LIM</sub>,"  $R_{SET}$  should be less than 11k $\Omega$ . 10.5k $\Omega$  is a standard value that is a little less than 11k $\Omega$  but very close. The chart reads approximately 0.700A as a typical I<sub>LIM</sub> value for 10.5k $\Omega$ . Multiplying 0.700A by 0.75 and 1.25 shows that the AAT4608 will limit the load current to greater than 0.525A, but less than 0.875A.

### Operation in Current Limit

When a heavy load is applied to the output of the AAT4608, the load current is limited to the value of I<sub>LIM</sub> determined by  $R_{SET}$  (see Figure 1). Since the load is demanding more current than I<sub>LIM</sub>, the voltage at the output drops. This causes the AAT4608 to dissipate a larger than normal quantity of power, and its die temperature to increase. When the die temperature exceeds an over-temperature limit, the AAT4608 will shut down until it has cooled sufficiently, at which point it will start up again. The AAT4608 will continue to cycle on and off until the load (or power) is removed.

### Reverse Voltage

The AAT4608 is designed to control current flowing from IN to OUT. If a voltage is applied to OUT which is greater than the voltage on IN, large currents may flow. This could cause damage to the AAT4608.

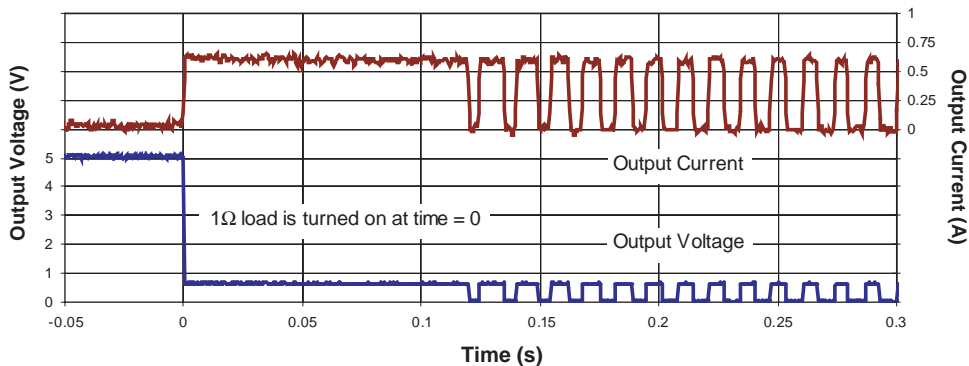

**Figure 1: Overload Operation.**

### Ordering Information

| Package | Marking <sup>1</sup> | Part Number (Tape and Reel) <sup>2</sup> |
|---------|----------------------|------------------------------------------|
| SOT23-5 | CMXY                 | AAT4608IGV-T1                            |



All AnalogicTech products are offered in Pb-free packaging. The term “Pb-free” means semiconductor products that are in compliance with current RoHS standards, including the requirement that lead not exceed 0.1% by weight in homogeneous materials. For more information, please visit our website at <http://www.analogictech.com/pbfree>.

### Package Information

#### SOT23-5

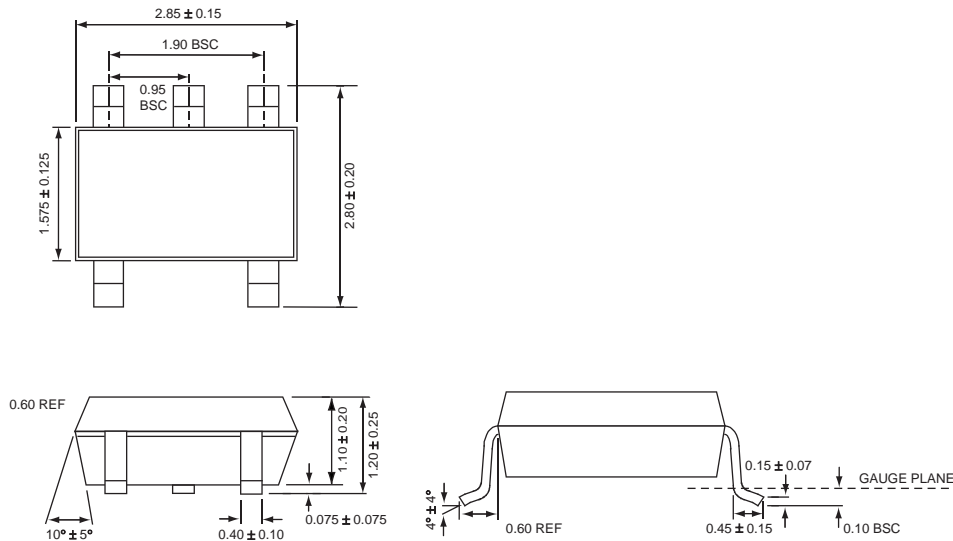

All dimensions in millimeters.

1. XYY = assembly and date code.
2. Sample stock is generally held on part numbers listed in **BOLD**.

© Advanced Analogic Technologies, Inc.

AnalogicTech cannot assume responsibility for use of any circuitry other than circuitry entirely embodied in an AnalogicTech product. No circuit patent licenses, copyrights, mask work rights, or other intellectual property rights are implied. AnalogicTech reserves the right to make changes to their products or specifications or to discontinue any product or service without notice. Customers are advised to obtain the latest version of relevant information to verify, before placing orders, that information being relied on is current and complete. All products are sold subject to the terms and conditions of sale supplied at the time of order acknowledgement, including those pertaining to warranty, patent infringement, and limitation of liability. AnalogicTech warrants performance of its semiconductor products to the specifications applicable at the time of sale in accordance with AnalogicTech's standard warranty. Testing and other quality control techniques are utilized to the extent AnalogicTech deems necessary to support this warranty. Specific testing of all parameters of each device is not necessarily performed.

**Advanced Analogic Technologies, Inc.**  
 830 E. Arques Avenue, Sunnyvale, CA 94085  
 Phone (408) 737-4600  
 Fax (408) 737-4611